

Press Brake

BB/BH series

Advanced Version



* The machines shown in the catalogue include some optional items and may vary in appearance from the actual machines.
 * Specifications and designs are subject to change without prior notice.

MURATA MACHINERY, LTD.
MACHINE TOOLS DIVISION



International Business Dept.
 2, Nakajima, Hashizume, Inuyama-shi, AICHI 484-8502, JAPAN
 Phone: +81-(0)568-61-3645 Fax: +81-(0)568-61-6455

Headquarters
 136, Takeda-Mukaishiro-cho, Fushimi-ku, KYOTO 612-8686, JAPAN
 Phone: +81-(0)75-672-8138 Fax: +81-(0)75-672-8691
<https://www.muratec.co.jp>

MURATA MACHINERY USA, INC
 2120 Queen City Drive, P.O.Box 667609, Charlotte, N.C. 28208, U.S.A.
 Phone: +1-704-875-9280 Fax: +1-704-392-6541
<https://www.muratec-usa.com>

MURATA DO BRASIL, LTDA.
 Estrada de Santa Isabel, 3383-KM 38,5,
 Itaquaquecetuba-SP, CEP 08599-000, BRASIL
 Phone: +55 (0)11-4648-6222 Fax: +55 (0)11-4648-6737
<http://www.muratec.com.br> e-mail: muratec@muratec.com.br

MURATA MACHINERY EUROPE GmbH
 Hanns-Martin-Schleyer-Strasse 3, D-47877, Willich, GERMANY
 Phone: +49-(0)2154-914-250 Fax: +49-(0)2154-914-283
 e-mail: info@muratec.de

MURATA MACHINERY (SHANGHAI) CO.,LTD
 [Registry Add]
 135 Fu Te Xi Yi Rd., Wai Gao Qiao Free Trade Zone, Pudong,
 Shanghai, CHINA

[Contact Add]
 150 Xin Gao Rd., Qingpu Industrial Zone,
 Shanghai, 201700, CHINA
 Phone: +86-(0)21-6921-2300 Fax: +86-(0)21-6921-2331

BEIJING BRANCH
 Rm. 309 Yu Lin Bldg., Xiang Jun Nan Li Er Xiang Jia No.5,
 Chaoyang-qu, Beijing, 100020, CHINA
 Phone: +86-(0)10-6597-3048 Fax: +86-(0)10-6591-1795

GUANGZHOU BRANCH
 Room 635, United Star Hotel, 172 Chang Gang Rd., C.,
 Guangzhou, 510250, CHINA
 Phone: +86-(0)20-8434-2882 Fax: +86-(0)20-8434-3463

MURATA (THAILAND) CO., LTD.
 898/43-44 SV CITY TOWER 2,25th Floor, Rama 3 Road Bangpoo, Bangkok 10120, THAILAND
 Phone: +66-(0)2294-7734-40 Fax: +66-(0)2294-7732

PT.MURATA MACHINERY INDONESIA
 Ruko Gyan Plaza D-4, Jl.Terusan Pasirkoja Blok 8,Bandung 40222, INDONESIA
 Phone: +62-(0)22-6046633 Fax: +62-(0)22-6046612

MURATA MACHINERY VIETNAM CO., LTD
 58 Nguyen Quy Duc street, An Phu Ward, District2, Ho Chi Minh City, VIETNAM
 Phone: +84-(0)28-6281-0601 Fax: +84-(0)28-6281-0860

MEIBAN ENGINEERING TECHNOLOGIES PVT.LTD.
 [An associate company of Murata Machinery, Ltd.]
 No 38, 7th Main, J.C. Industrial Estate, Yelachanahalli, Kanakapura Road,
 Bangalore -560 062 INDIA
 Phone: +91-(0)80-2686-0600 Fax: +91-(0)80-2686-0605
<http://www.meibanengg.com> e-mail: office@meibanengg.com

CAT.NO.22P2592 A 19-06-3(X-TU)

Press Brake

BB/BH series Advanced Version



BH25040

Dual Drive Press Brake

BH series

BH13530

Machine with option installed



BB4013

Machine with option installed

Ball Screw Press Brake

BB series

Muratec press brake has evolved further.





Muratec's press brake improves operating efficiency and productivity improvement

- 22 inches wide display
- Equipped with a completely renewed UI / MOS (Muratec Operating System)
- The data has been centrally managed from the 3D model.
- Quick response



Point 1

Easy-to-see and easy to use due to the large size of the operation panel.

Easy to see with 22" wide display.
With multi-touch support and improved user friendly features.



Point 2

New UI, enhanced operator support function

It is equipped with the newly developed MOS (Muratec Operating System), which has a completely redesigned UI (user interface). The operator support function has been enhanced, including an announcement and an indicator to notify the machine status.

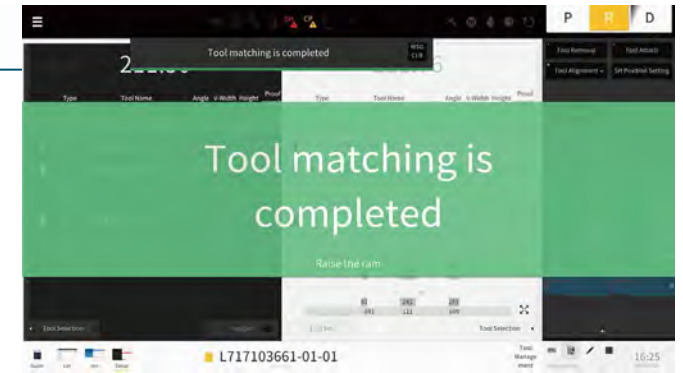

Point 3

Enhance CAD / CAM file compatibility

The compatibility with other companies' CAD / CAM files has been enhanced by supporting the Sheet Metal CAM Common Interface SCPX (Sheet metal CAM PartseXchange).

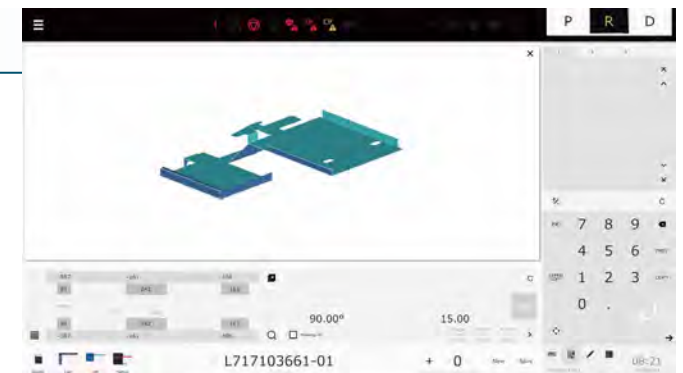

Point 4

Cycle time reduction

Ram's operational response has been improved with the newly developed Advanced Ram Acceleration Control (ARAC) technology.

About 30% UP compared to our conventional machine

* Number of cycles per minute under certain conditions

Point 5

Improved workability by reducing the weight of the tool clamp

Achieving compactness and weight reduction by changing only the width from 200 mm to 150 mm while maintaining the clamp height at 150 mm for deep box bending. It is possible to flexibly cope with various bending processes without changing the deep bending size.

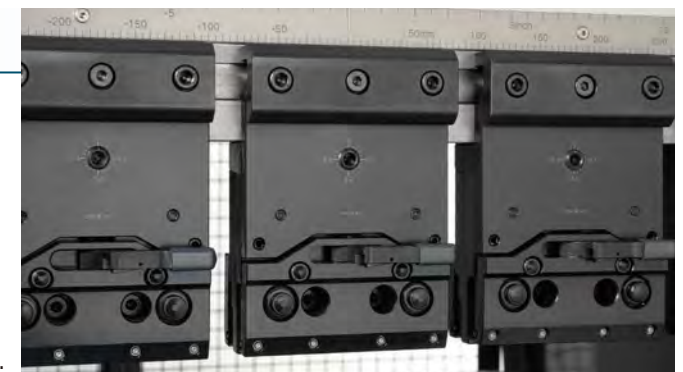



Dual Drive Press Brake

The Dual Drive Press Brake BH series incorporates a dual drive system that controls the high-speed vertical movement of the ram by AC servomotor and ball screw drive, and the tonnage generation by hydraulic pressure separately. High speed drive and stable repeated stop accuracy enable high productivity.

Dual drive system

The dual drive system is different from the conventional servo hydraulic mechanism which continuously controls the high speed operation and the pressurization operation of the ram, it separates the high speed up and down operation by the AC servo motor & ball screw drive from the pressurization operation by the hydraulic pressure. This dual drive system achieves high productivity by enabling high-speed descent of 200 mm / sec and stable repetitive stop accuracy with AC servo motor & hybrid. In addition, it is equipped with an assist device that uses the energy when the ram descends when the ram ascends, making it a total energy saving drive system.

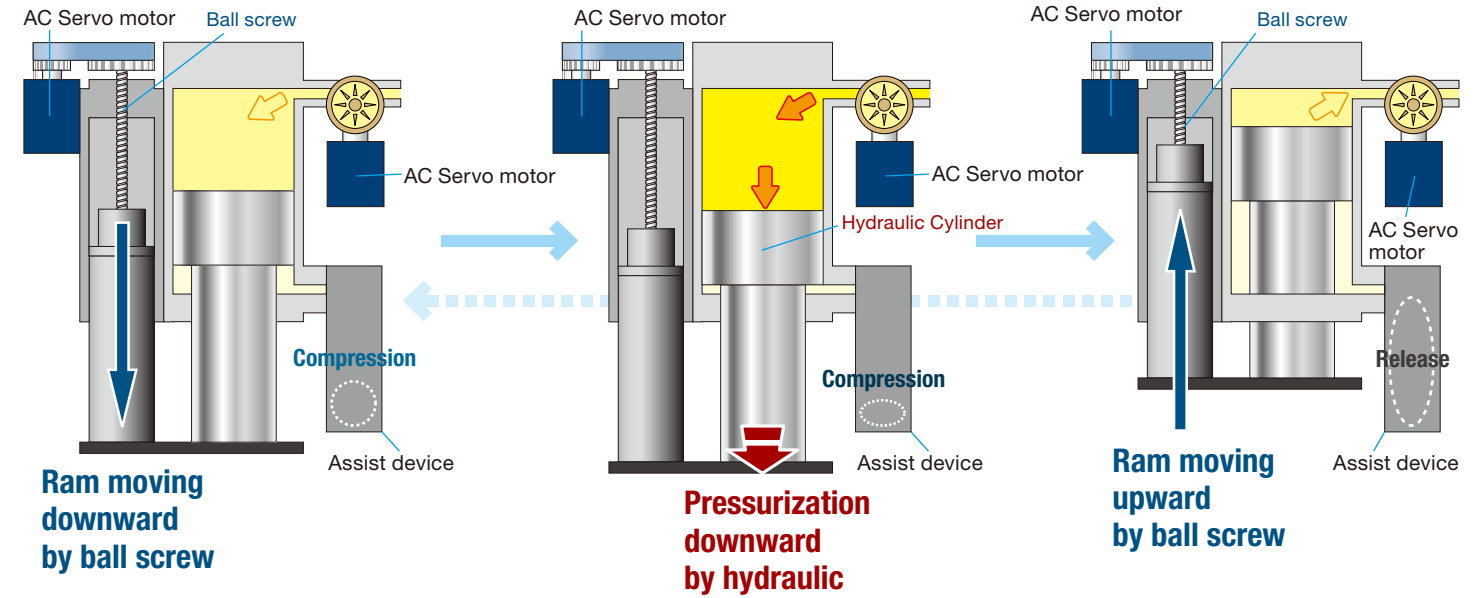

High stop-accuracy by linear scale

In dual drive control, the drive is switched in the middle of a stroke from ball screw control to hybrid control, but the position is monitored by the linear scale on all strokes, so stable stop accuracy is obtained without the influence of oil temperature or pressure.

Linear scale



Accumulator assist

Assisted by the accumulator, the weight of the ram is canceled and the small AC servomotor and ball screw allow the ram to rise rapidly, providing quiet operation and energy saving effects.

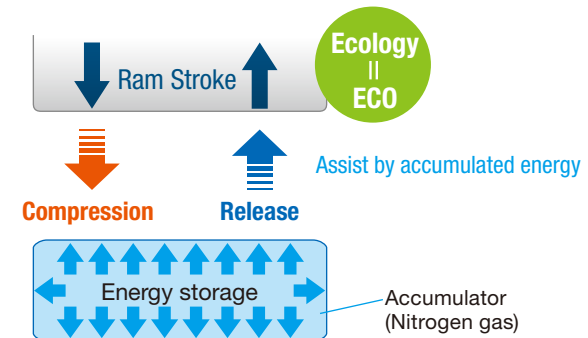

Compact hydraulic tank



High rigidity frame / crowning system

The IdealCurve Crowning System is the result of thorough FEM analysis of the frame structure to obtain an ideal correction curve for crowning, the fate of press brakes. Simple and fine adjustment is possible using a multi wedge crowning wedge. All operations can be adjusted for each process in a short time by the controller, and can be used without stress in normal operation.

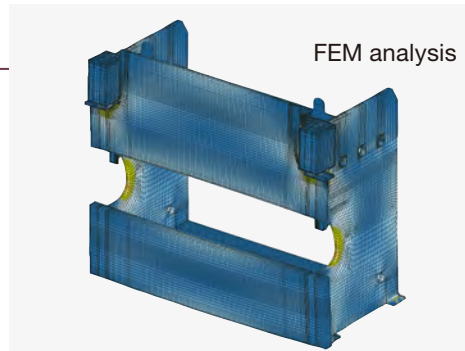

FEM analysis

Crowning correction

Starting with the data from the FEM analysis the crowning correction is done easily and is able to achieve high accuracy due to the micro wedge crowning device, FEM analysis and High frame rigidity.

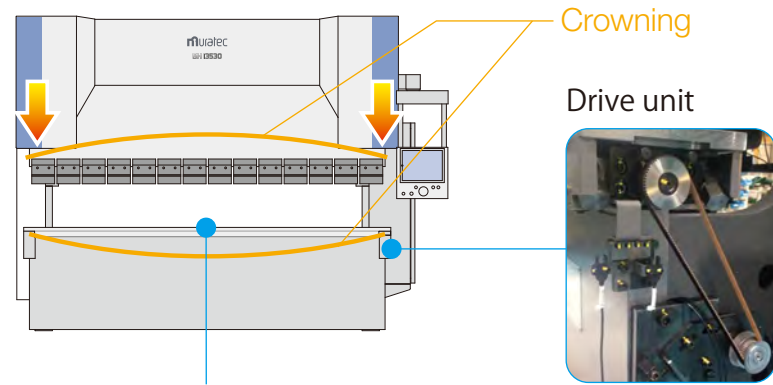

Crowning

Drive unit

Internal of carving wedge

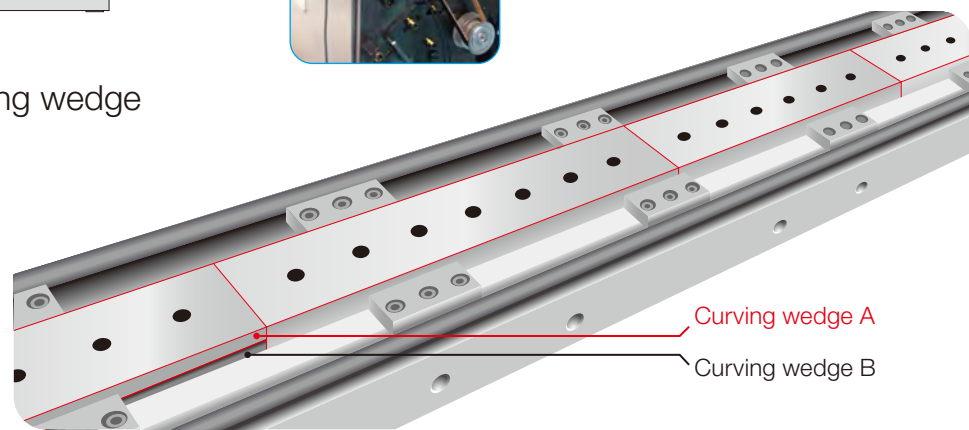

Curving wedge A

Curving wedge B

without correction



With correction

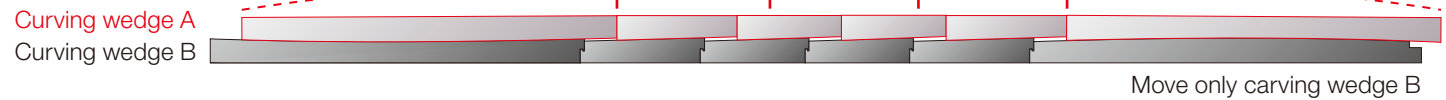

Move only curving wedge B

Adjust each step in a short time with the correction function

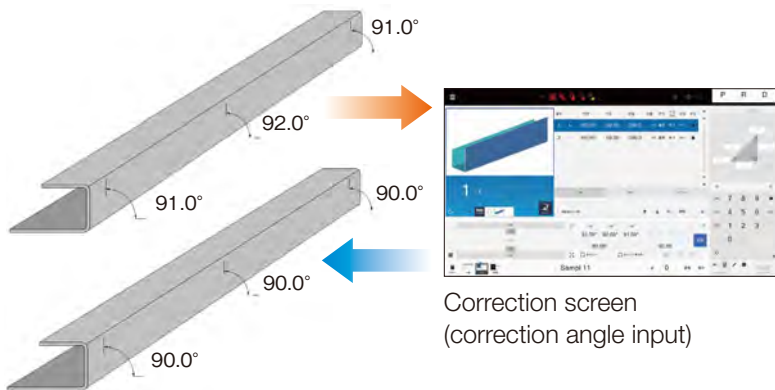

Correction screen (correction angle input)

Ideal crowning correction curve profile

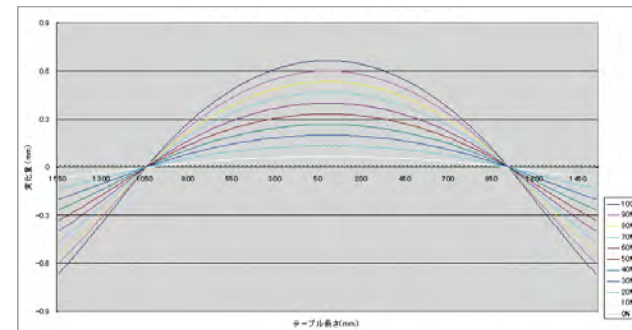

Adjust the deflection in various conditions.

PSP (Press Start Point) function

PSP function

The PSP function is a function that checks the thickness error for each workpiece and reduces the range of angle variation.

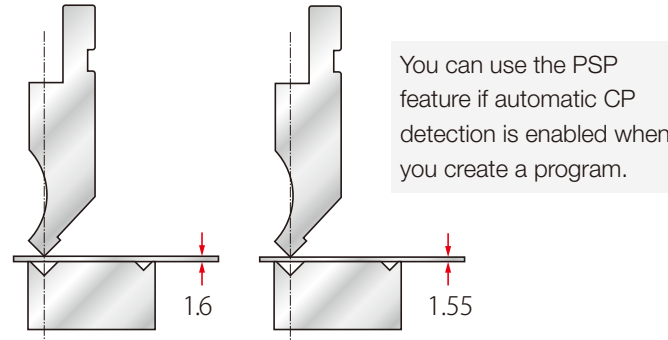

You can use the PSP feature if automatic CP detection is enabled when you create a program.

The effect of PSP operation

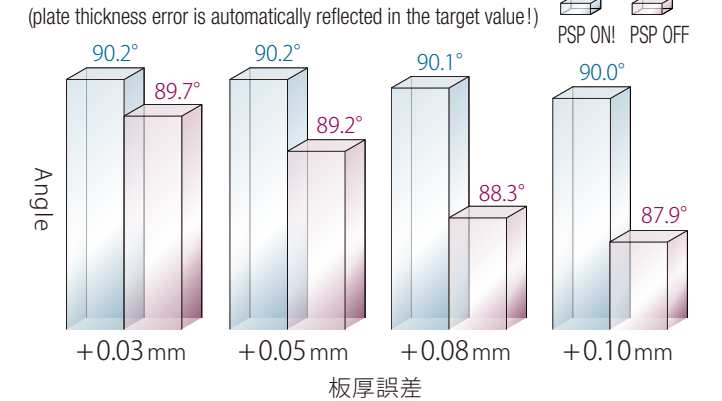

* This data is the result of in-house test with SPCC 1.6 mm L150 mm V10 mm.

CP detection

(adjusts errors in bending angle calculations)

In CP detection, the reference point is actually measured with a bending tool and material, therefore, errors in tool height and errors in thickness of the material are adjusted to improve accuracy of bending angle calculations. (*Workpieces targeted for automatic CP detection have conditions.)

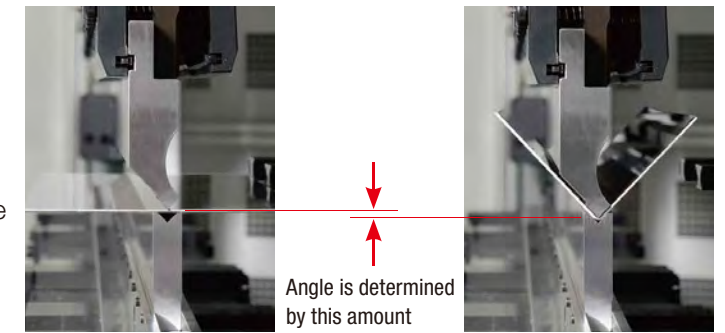

Angle is determined by this amount

High precision back gauge

5(7) Back gauge for axis control with high accuracy and rigidity

Specifications

Y axis St 700 mm Y axis speed 50 m/min
Z axis St 200 mm X axis speed 50 m/min
ZX axis speed 10 m/min

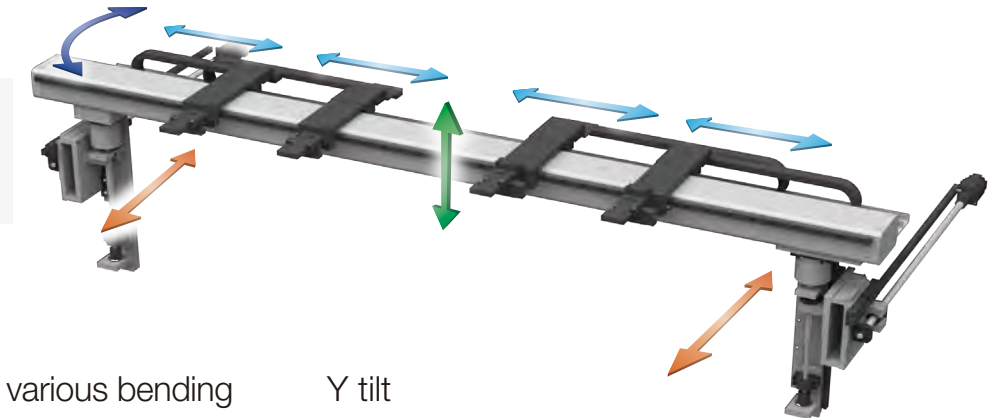

Back gauge corresponding to various bending



The high speed, high accuracy and effective stroke 700 mm (standard specification) back gauge is a back gauge compatible with various bending.

Y tilt



Since the back gauge can be tilted left freely by the tilt mechanism (maximum inclination 500 mm), it is possible to easily set the taper bending with different left and right dimensions.

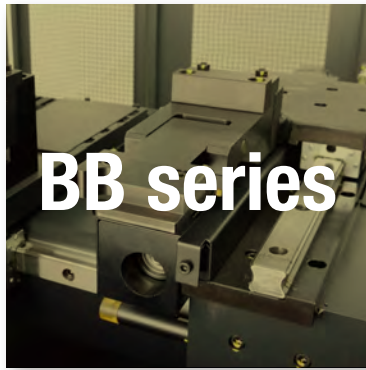

Ball Screw Press Brake

The ball screw press brake achieves high productivity by AC high speed drive and stable repeated stop accuracy of ram by AC servomotor & ball screw drive.

Ball screw drive system

The ram axis uses an AC servomotor and a ball screw drive driven by a ball screw to enable high-speed operation of 100 mm / sec and stable repeated stop accuracy, achieving high productivity. It is an excellent drive system with excellent environmental performance, such as oil-less and low noise due to a reduction gear.

- High-speed operation by ball screw drive
- Stable high repeatability by ball screw drive
- Environmental performance (oilless, low noise due to reducer)

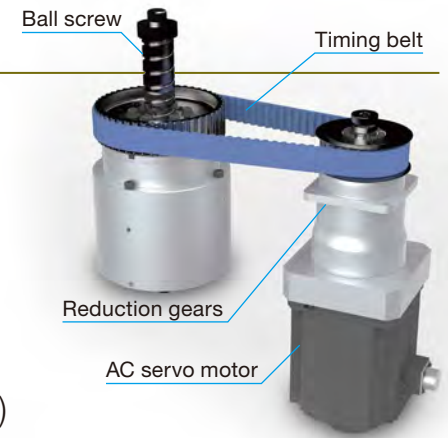

Ball screw drive mechanism

Ram axis repeatable stop accuracy (no load 100 times)

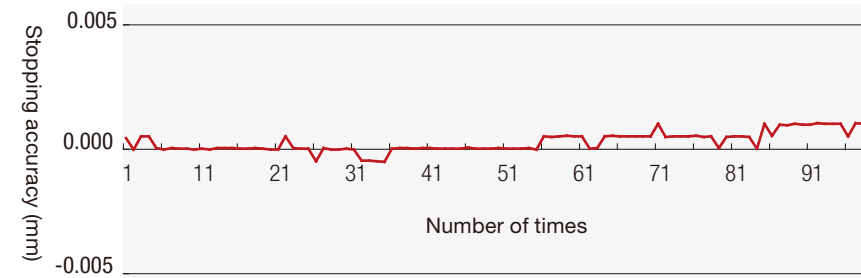

Ram stroke: 50 mm
High speed down: 100 mm / sec
Pressure down: 5 mm / sec

* This graph is experimental data.

High rigidity offset frame (BB4013)

The small gap and high rigidity offset frame suppresses the opening of the frame and provides higher frame rigidity. In addition, by widening the side frame to the left and right, a large working space is secured, and since the back gauge can be used effectively over the entire length of the machine, tool placement and Step-Bend is facilitated.

The wide space allows the back gauge to be used up to the full machine length, enabling effective Step-Bend.

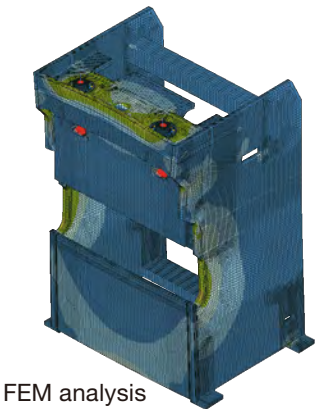
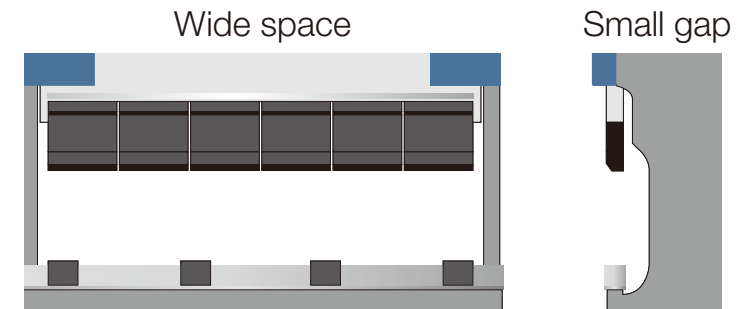

FEM analysis

High precision back gauge

High-speed, high-precision, effective stroke 500 mm (standard specification) back gauge supports various bending.

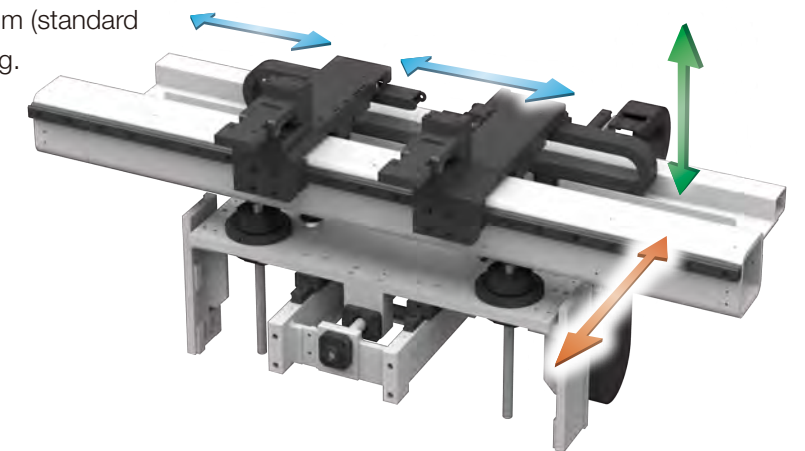

Specifications

Y axis St 500 mm	Y axis speed 50 m/min
Z axis St 150 mm	X axis speed 50 m/min
	ZX axis speed 10 m/min



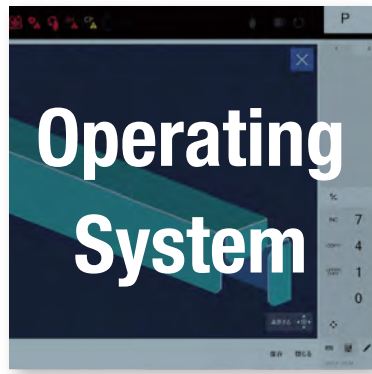

MOS (Muratec Operating System)

Equipped with a newly developed MOS (Muratec Operating System) with a completely redesigned user interface. We have enhanced the operator support function and realized interface design in pursuit of safety and ease of use.



Interface design in pursuit of safety and ease of use

Setup

Tool exchange

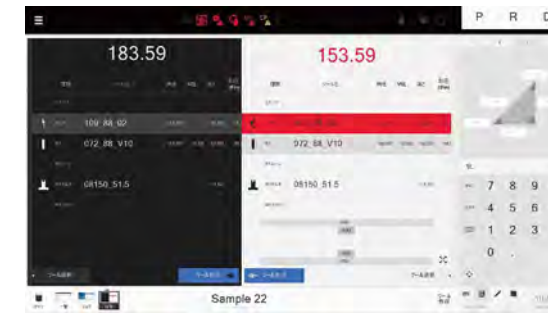

The tools attached to the machine and the tools selected in the program are arranged on the left and right, and the shape is displayed, so you can judge the setup at a glance.

Programming

Angle input

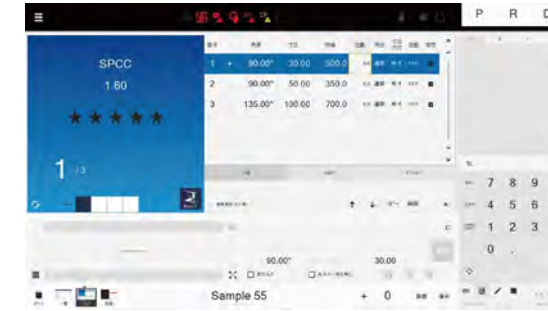

Variety of programming methods can be selected according to work piece, such as shape and quantity.

Shape input

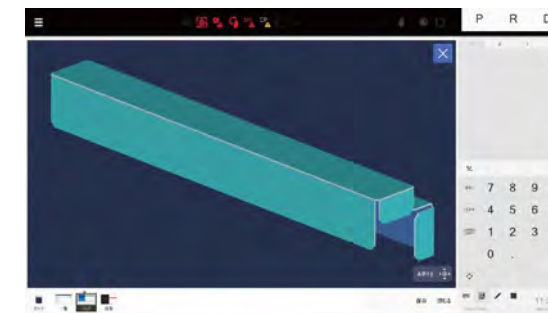

Cross section input



Job

Program list



Machining is possible only by calling the program from the program list. Program data is also managed in folders, so external storage data can be easily recalled.

Externally saved data



processing





Bending Simulator and sheet metal CAM common interface SCPX

SCPX

Sheet metal CAM Part eXchange
(Muratec original open format)

Compatibility with third-party CAD / CAM files has been enhanced through the support of XML format (SCPX) that can express the shape of sheet metal parts and CAM information.

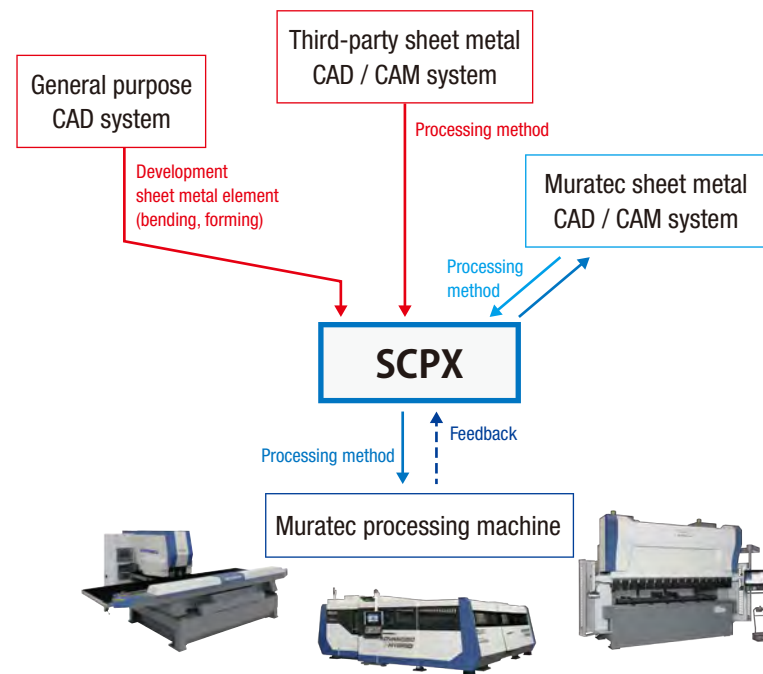

Bending Simulator Features

SCPX loading

To build a smart network by Muratec original open format SCPX.



3D model display

The workpiece shape can be displayed in 3D.

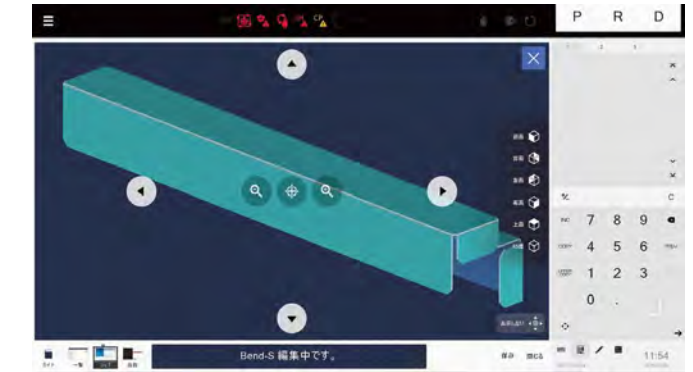

Bend sequence specification

The bend sequence and tool are calculated automatically, and if you want to edit for each part, you can easily edit it.

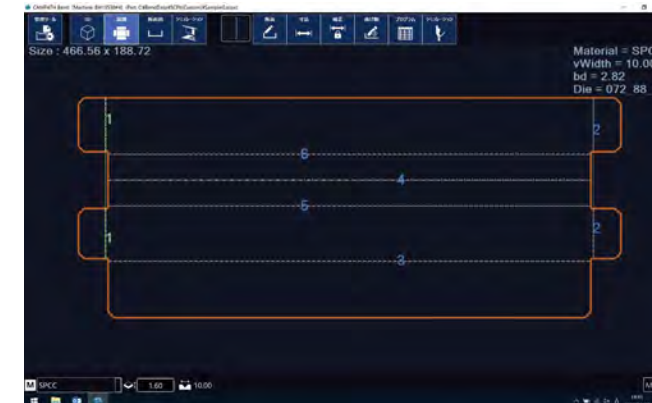

Tool selection & attached position indication

It is possible to easily check tool selection and tool layout.

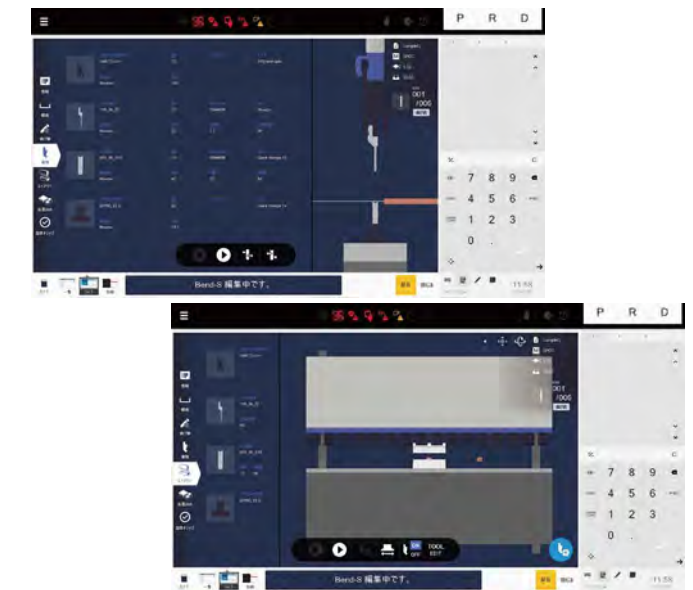

2D bending simulation

The collision between tool and workpiece can be easily confirmed by 2D simulation.

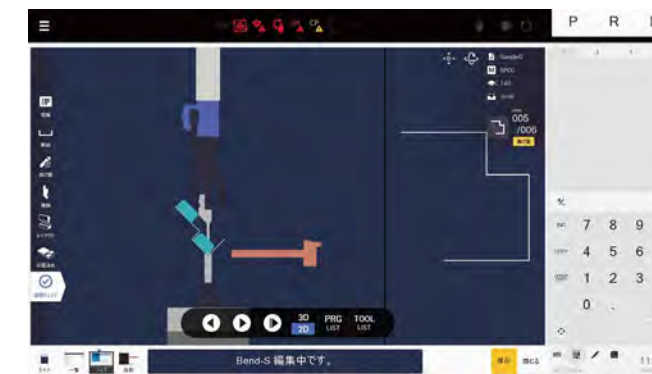

3D bending simulation

You can visually confirm the actual bending by 3D simulation.



Bending Simulator workflow

Save 3D data in SCPX format

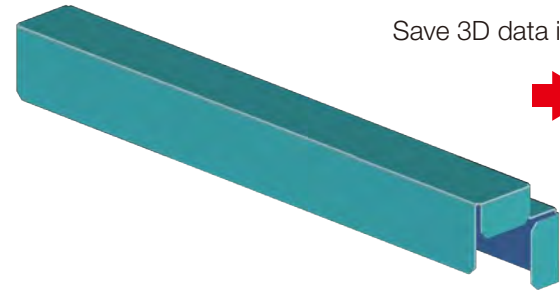

Save 3D data in SCPX format

* Sheet metal model that 3D data can be expressed as SCPX data

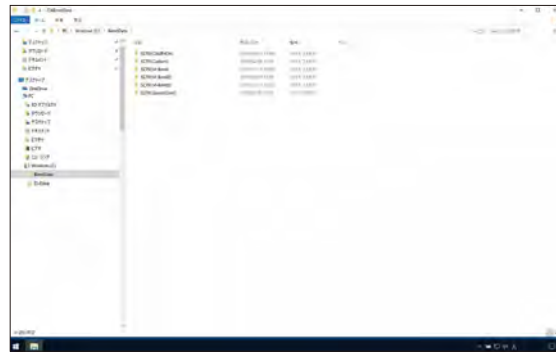

Data read (SCPX)



Bend sequence · Automatic selection of tool & verification by simulation



Unique algorithm with short automatic search time, automatic calculation of Bend sequence and tool selection.

Bending data creation

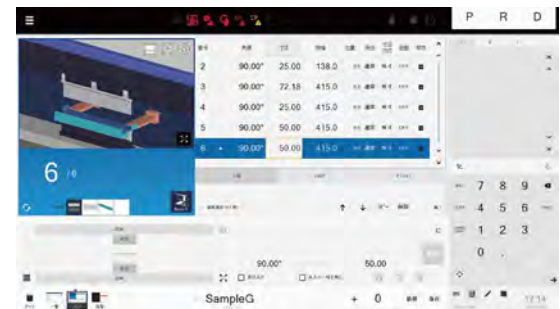

If you save the automatically calculated data, bending data will be generated automatically.

Useful Features of Bending Simulator

Bend sequence editing

When editing the bend sequence, you can easily change it as you can select the bend sequence while checking the 3D and 2D bending simulation of each process.

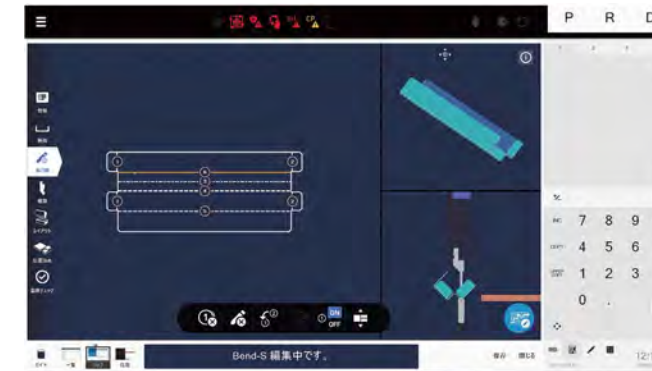

Simple 3D display

Bending simulation data created with Profile (2D) can be displayed in simple 3D. You can check the workpiece visually.



Bending collision prediction function

Function to predict bending collision (Dead End Detection).

When manually specifying the bend sequence, if the process is bent but it can not be bent due to a collision after that process, it displays "This collision is predicted" and guides the operator in advance.



Easy gauging

The back gauge stopper has a Y-axis snap and X-axis can be freely dragged to the desired position.

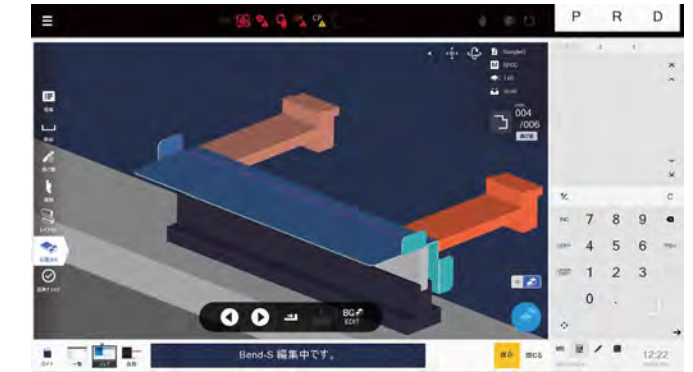



Safety Work

We support the work of press brake safely with various devices.

Design for safety

Common to BB series and BH series

① LED light

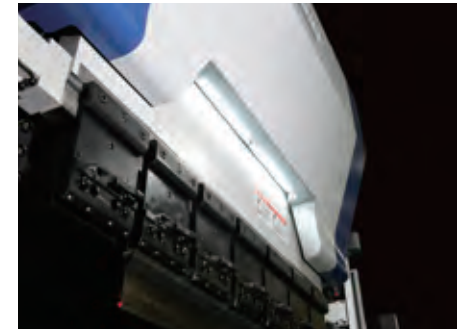

We adopt LED with high energy saving effect. We gently support the operators by illuminating the hand and the inside of the machine.

②



LED lighting for big machines

③ Safety pin

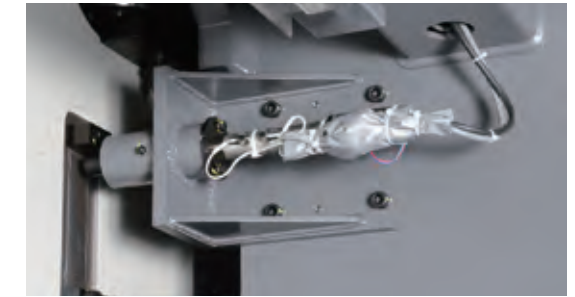

By inserting the safety pin during maintenance, you can work more safely.



④ Side guard with Interlock option

It guards the moving area from the side of the machine, prevents unexpected danger and ensures safe work. Once the side guard is open, the machine will not operate until the interlock is released.

Tool exchange mode



It is a dedicated mode for tool change with limited speed, pressure and speed to minimize the risk of tool damage.



Rear safety fence with interlock



BB series



BH series

It guards against intrusion into the moving area from the rear of the machine, protects against accidental hazards and ensures safe work. If the rear safety fence is open, the machine will not operate until the interlock is released.

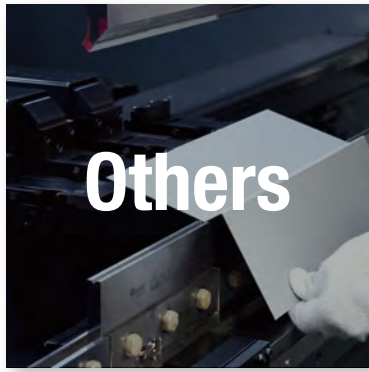

Others

Others Endless part shapes can be formed with the standard features and options available.

Sample work.



Handling a wide variety of work pieces

Back gauge Fingers

Materials can be placed on the upper surface of the Finger support part, therefore, stable processing is enabled without material sagging in the case where a deep material is bent.



Tapered bending (Conical bending)

The back gauge can be tilted obliquely, it is thereby possible to easily perform obliquely gauging, etc. Depending on the shape, conical bending processing, etc., is enabled.

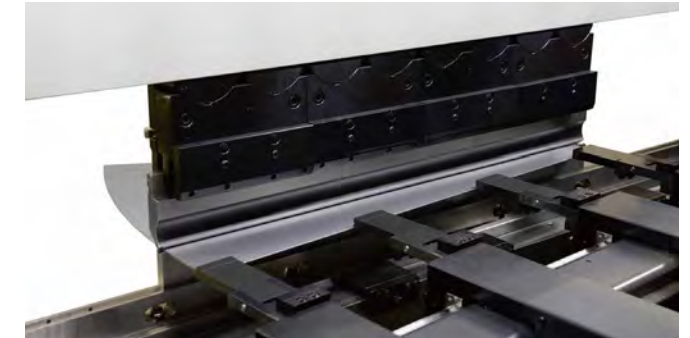

Deep Box bending

The tool clamp height is 150mm to allow for freely moving in the right and left directions, therefore, Deep box bending such as switchboards and electrical box can be processed.



Window Bending

It is possible to process even deep U-shaped bending that collides with the ram (depending on the size).



Radius Bending

The high precision positioning back gauge enables R-shapes to be formed by radius bending with pitch feed.



Pre-Bend

In the case of reverse bending higher than that of the lower tool, depending on the shape, it can be bent in two bends by the Pre-Bend function.





Option

Various options raise production efficiency.

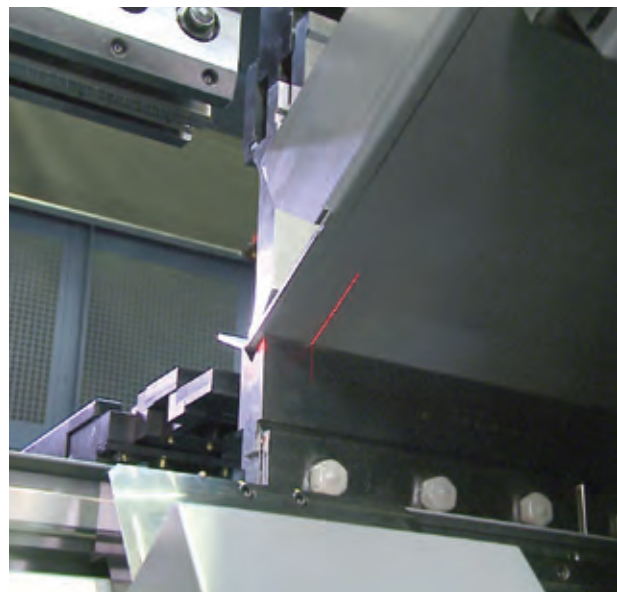

Angle measurement

AMS
(Angle Measurement System)

Applicable model: BH series



AMS is a 2-axis control laser-type angle measurement system that anyone can process to the target angle in one operation.

IRIS PLUS
(safety device with angle measurement function)

Applicable model: BB series



IRIS Plus is a laser safety device with an angle measurement function that improves press brake productivity.

Wireless digital protractor
(Bluetooth)

Applicable model: BH/BB series



It is a digital protractor with built-in Bluetooth function that can transmit the measured data directly to the controller. Measurement data can be input without direct input to the controller.

Sheet Follower (Applicable model: BH series)

SF-70 (load capacity 70 kg)



Servo Sheet Follower SF-70 supports bending of large panels etc.

SF-150 (load capacity 150 kg)



The SF150 is a hybrid drive Sheet Follower that supports bending of heavy work to achieve "safety work", "saving labor", and "improvement of product accuracy".

Laser safety device (Applicable model: BH/BB series)

Lazer Safe (Sentinel PLUS)

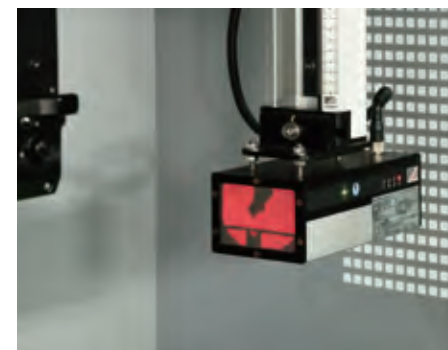

AKS 3PF



DSP-J



It is a safety device for practical press brakes that are allowed to operate the machine at a speed of 10 mm / sec even when the laser beam is Shading. Ensure the safety of workers.

Clamp corresponding to various tools (Applicable model: BH/BB series)

Ountouch Clamp (Standard)



The tool can be installed easily by opening and closing with the clamp lever.

Manual Clamp



This holder is a type that clamps the tool with a bolt.

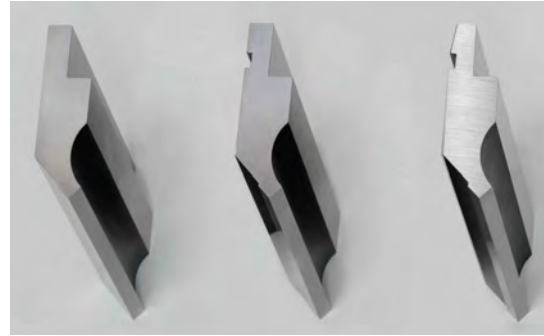

Any European-type tool can be clamped.

American Tool Clamp



Wila Type



Type compatible with the global tool maker WILA. Hydraulic clamps and safety clicks make it possible to significantly reduce tool replacement time.

Sub clamp (manual only) (Applicable model: BH/BB series)

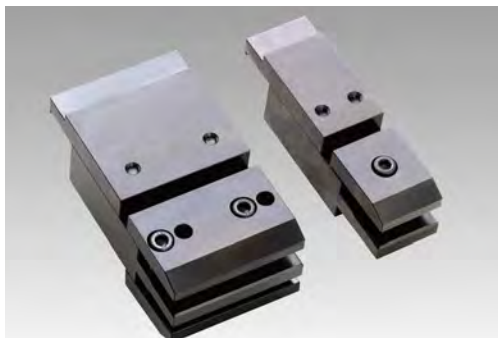

By combining the standard clamp L150mm, sub clamp L100mm and L50mm, it is possible to cope with various bendings by avoiding collision with clamps such as narrow box bending.

Clamp Adapter (Applicable model: BH series)



Clamp adapter prepares 100mm and 200mm. Attaching a clamp adapter, deep box bending is possible. EX. The photo shows 300mm deep box bending possible by attaching clamp adapter 200mm + mold H120mm. Deep box bending size also varies depending on the tool.

Back Gauge Option (Applicable model: BH/BB series)

FF Axis for BH

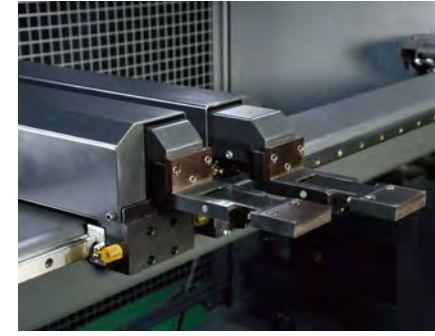

The left and right stoppers shift their FF axes forward by +200 mm.

FF Axis for BB

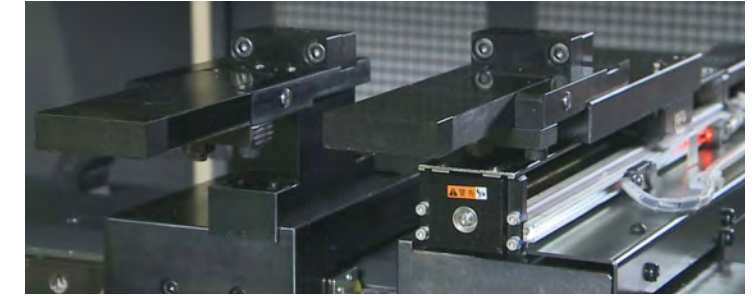

The left stopper FF axis shifts ± 100 mm back and forth.

Stopper tip

Flat Type (Standard)

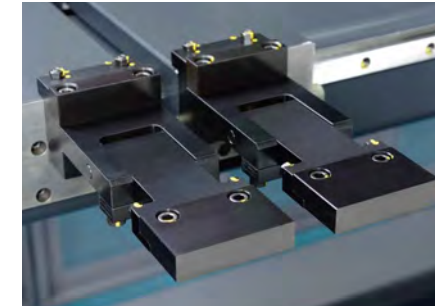

Crab Claw



Special Stopper

Touch Sensor

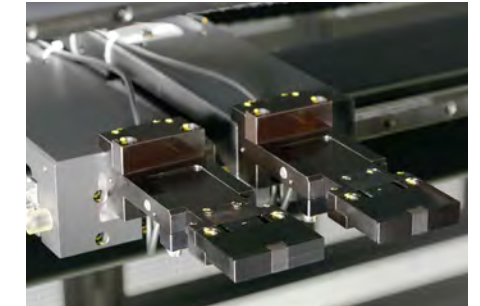

Other

Wide Open Height

Applicable model: BH/BB series



This improves the handling of work during deep box bending, which is often used in control panel processing.

Movable foot switch

Applicable model: BH series



Movable foot switch is quite useful to step bend of small parts, easy to operate, and then gently support the operators.

Front Support

Maximum load 50 kg / unit
Applicable model: BH/BB series



Front Support (With Scale)

Maximum load 50 kg / unit
Applicable model: BH/BB series



Front Support (Lightweight type)

Maximum load 20 kg / unit
Applicable model: BH/BB series



Auto Crowning

Applicable model: BB6020



Specification

BH series

Specifications		BH8525	BH13530	BH18530	BH18540	BH25030	BH25040
Press force	kN	833	1323	1813	1813	2450	2450
	ton	85	135	185	185	250	250
Bending length	mm	2600	3100	3100	4100	3100	4100
A Table length	mm	2600	3100	3100	4100	3100	4100
B Distance between frames	mm	2200	2700	2700	3700	2700	3700
C Table width	mm	170	170	170	210	210	210
D Open height	mm	380	380	380	380	380	380
E Table height	mm	900	900	900	900	900	900
F Machine depth	mm	1375	1460	1585	1610	1710	1710
G Gap depth	mm	400	400	400	400	400	400
H Height from floor	mm	2950	2990	2990	3130	3095	3230
I Ram stroke	mm	250	250	250	250	250	250
J Total depth	mm	2400	2460	2470	2470	2570	2570
K Safety door depth ^{*2}	mm	3719	4239	4419	5419	4419	5419
L Total width	mm	3033	3543	3750	4750	3785	4785
M Control panel turn area	mm	1360	1186	1111	1061	1111	1061
Ram Speed	Approach	mm/s	2~200	2~200	2~200	2~200	2~200
	Bending	mm/s	0.1~10	0.1~10	0.1~10	0.1~10	0.1~10
	Return	mm/s	2~200	2~200	2~200	2~200	2~200
Power requirement	kVA	9	12	22	22	27	27
Weight	ton	7	9.5	15	18	19	22

BB series

Specifications		BB4013	BB6013	BB6020	
Press force	kN	353	539	539	
	ton	36	55	55	
Bending length	mm	1260	1300	2100	
A Table length	mm	1400	1300	2100	
B Distance between frames	mm	1300	900	1700	
C Table width	mm	100	100	100	
D Open height	mm	280	280	280	
E Table height	mm	900	900	900	
F Machine depth	mm	1120	1360	1360	
G Gap depth	mm	100	400	400	
H Height from floor	mm	2390	2610	2610	
I Ram stroke	mm	150	150	150	
J Total depth	mm	2005	2260	2320	
K Safety door depth ^{*2}	mm	2296	2260	3060	
L Machine width	mm	1630	1624	2425	
M Control panel turn area	mm	1156	1281	1300	
Ram Speed	Approach	mm/s	1~100	0.95~95	0.95~95
	Bending	mm/s	0.2~20	0.2~20	0.2~20
	Return	mm/s	1~100	0.95~95	0.95~95
Power requirement	kVA	15	21	21	
Motor	kW	5.0	7.0	7.0	
Weight	ton	3.5	4.5	5.0	

*1: In transport condition

*2: This dimension is when the side guard (option) is installed.

BH series

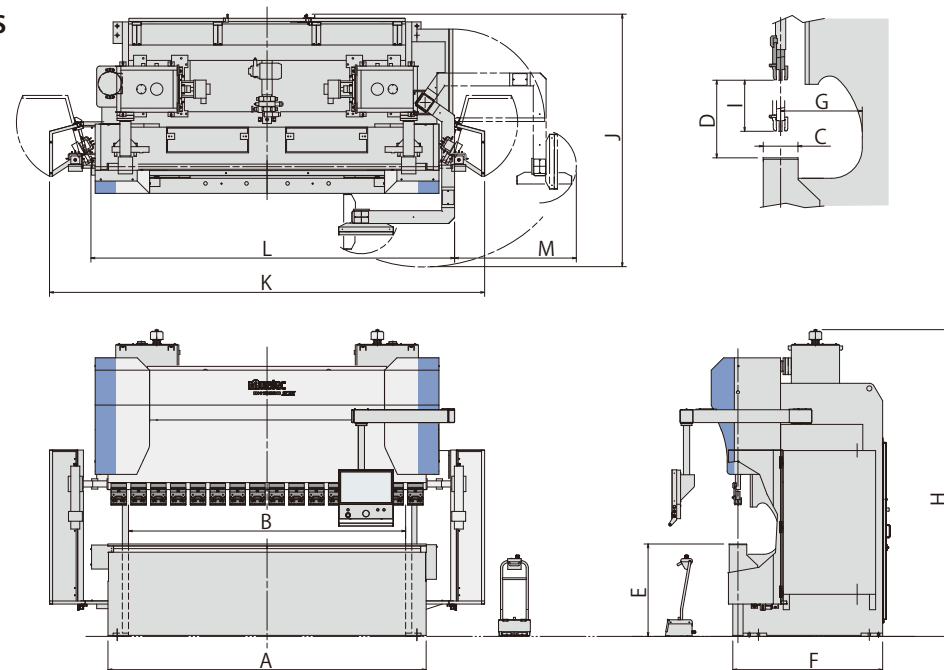

BB4013

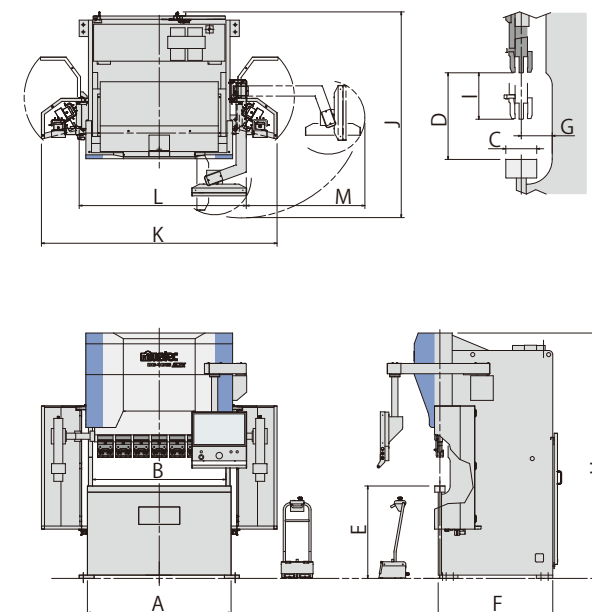

BB6013 / BB6020

